

INSIGHT R PROFILE

SUSPENDED

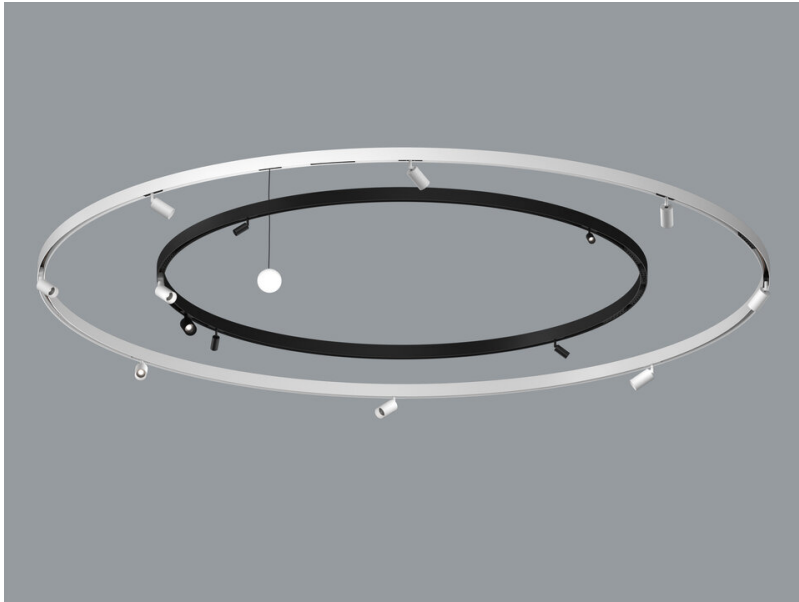

Application: offices, shops, entrance lobbies, apartments

Housing: cast aluminum

Power Supply: electronic, 48V, to be ordered separately

Other: mechanical connectors and suspensions (2 pcs per rail) included. Electrical accessories are required for the proper operation of the system. Supply voltage - 48V DC.



TECHNICAL DATA

Diameter D	2000, 3000, 5000 mm
The color of the housing	White RAL9016, Black RAL9005
IP	IP20
Supply voltage	48V DC

[mm]

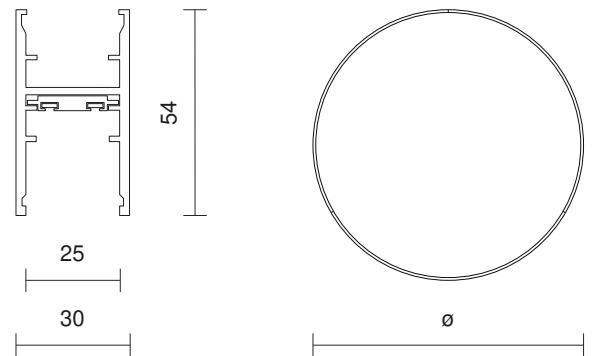

The dimensions and technical information provided are for reference only. Actual data may slightly differ due to the manufacturing process. Spectra Lighting reserves the right to change the presented materials and technical parameters of products without prior notice. The photos show an illustrative representation of products and colors. The finish, color and appearance of the optics depend on the choice of the luminaire and may be different than shown in the photo.

INSIGHT R PROFILE

SUSPENDED



Accessories

Connectors

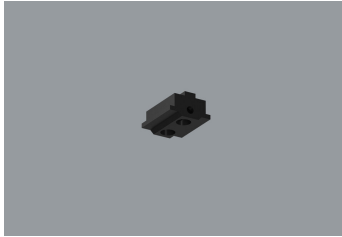

Insight R - Linear mechanical connector + screw

Code	Name
36.1065.03	Insight R Linear mechanical connector + screw for Profile R, black, set=2pcs RAL9005

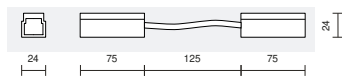
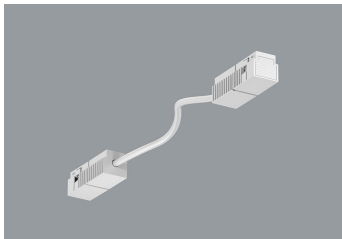

Insight R- Flexible electrical connector, 48V/DC

Code	Name
36.1030.01	Insight R Flexible electrical connector, 48V/DC, white RAL9016
36.1030.03	Insight R Flexible electrical connector, 48V/DC, black RAL9005

The dimensions and technical information provided are for reference only. Actual data may slightly differ due to the manufacturing process. Spectra Lighting reserves the right to change the presented materials and technical parameters of products without prior notice. The photos show an illustrative representation of products and colors. The finish, color and appearance of the optics depend on the choice of the luminaire and may be different than shown in the photo.

INSIGHT R PROFILE

SUSPENDED

Wiring

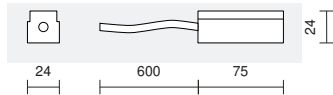
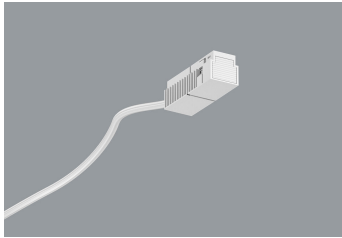

Insight R - Power terminal with cable L=600mm, 48V/DC

Code	Name
36.1034.01	Insight R Power terminal with cable L=600mm, 48V/DC, white RAL9016
36.1034.03	Insight R Power terminal with cable L=600mm, 48V/DC, black RAL9005

Suspensions

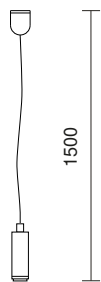
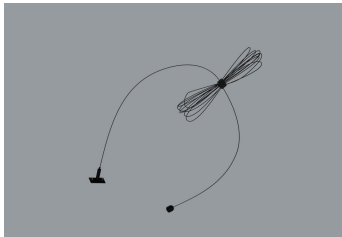

Insight R - Suspension wire L=1500mm for Profile R

Code	Name
36.1060.03	Insight R Suspension wire L=1500mm for Profile R, black RAL9005

The dimensions and technical information provided are for reference only. Actual data may slightly differ due to the manufacturing process. Spectra Lighting reserves the right to change the presented materials and technical parameters of products without prior notice. The photos show an illustrative representation of products and colors. The finish, color and appearance of the optics depend on the choice of the luminaire and may be different than shown in the photo.